

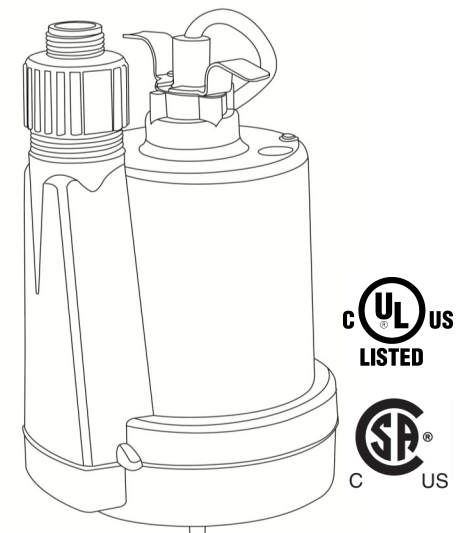



**INSTALLATION & OPERATION
MANUAL
UTILITY PUMP
Model: MLP71025**





Safety Guidelines

Carefully read, understand and follow all safety instructions in this manual.

 This is the safety alert symbol. When you see this symbol, look for one of the following signal words.

 **DANGER** Indicates a hazardous situation which, if not avoided, will result in death or serious injury.

 **CAUTION** Indicates a hazardous situation which, if not avoided, could result in death or serious injury.

 **WARNING** Indicates a hazardous situation which, if not avoided, could result in minor or moderate injury.

Safety Information

Read these warnings carefully. Know the application and limitations of this pump. Failure to follow these warnings could result in serious bodily injury and/or property damage.

 **DANGER** RISK OF ELECTRICAL SHOCK. Disconnect and lockout power supply before removing old pump or installing or servicing this pump.

 **DANGER** RISK OF ELECTRICAL SHOCK. This pump is supplied with a grounding conductor and grounding type attachment plug. To reduce the risk of electric shock, be certain that it is connected only to a properly grounded, grounding type receptacle. For added safety, it is highly recommended to connect this pump to a GFCI (Ground Fault Circuit Interrupter) outlet.

 **WARNING** The installation of this pump must be in accordance with the National Electric Code (NEC), Uniform Plumbing Code (UPC), International Plumbing Code (IPC) as well as all applicable local codes and ordinances.

 **CAUTION** Do not install this pump in any location classified as hazardous by the National Electrical Code, ANSI/NFPA70.

 **CAUTION** Do not use this pump to pump flammable or explosive fluids such as gasoline, kerosene, etc. Do not use this pump in flammable or explosive environments. Use only with liquids compatible with pump component materials.

 **WARNING** RISK OF ELECTRICAL SHOCK. This pump has not been investigated for use in swimming pool or marine areas.

 **WARNING** RISK OF ELECTRICAL SHOCK. **DO NOT** use the power cord to install or carry the pump. Always use the handle. The cord may pull apart exposing bare wires which could cause a fire or electrical shock. Use the handle supplied with the pump for installing and transporting the pump.

 **WARNING** Do not run pump dry. This pump relies on water for cooling. Running the pump dry can cause the pump to overheat and the possibility of burns to anyone that handles the pump. Running the pump dry will void the warranty.

 **WARNING** Make certain that the electrical outlet is within the reach of the power supply cord. **DO NOT USE AN EXTENSION CORD.** Extension cords that are too long or too light do not deliver sufficient voltage to the pump motor. More importantly, they present a safety hazard if the insulation were to become damaged or the connection end were to fall into the water.

LIMITED WARRANTY - UTILITY PUMPS:

Manufacturer warrants the products specified in this warranty to be free from defects in material or workmanship for three (3) years from date of purchase. During the time period and subject to the terms and conditions, the manufacturer will repair or replace to the original user or consumer any portion of this product which proves to be defective due to materials or workmanship. At all times the manufacturer shall have and possess the sole right and option to determine whether to repair or replace defective equipment, parts, or components. The manufacturer has the option to inspect any product returned under warranty to confirm that the warranty applies before repair or replacement under warranty is approved. This warranty sets forth the manufacturer's sole obligation and purchaser's exclusive remedy for defective product. Return defective product to the place of purchase for warranty consideration.

WARRANTY PERIOD - PRODUCTS:

If, within the duration of product use by the original user, this product proves to be defective due to materials or workmanship, the product shall be repaired or replaced at the manufacturer's option, subject to the terms and conditions set forth in this warranty statement. Proof of purchase is required for warranty consideration. In the absence of suitable proof of the purchase date, the effective period of this warranty is 12 months from the product's date of manufacture.

LABOR, ETC. COSTS:

The manufacturer shall IN NO EVENT be responsible or liable for the cost of field labor or other charges incurred by any customer in removing and/or affixing any product, part, or component thereof.

PRODUCT IMPROVEMENTS:

The manufacturer reserves the right to change or improve its products or any portions thereof without being obligated to provide such a change or improvement for units sold and/or shipped prior to such change or improvement.

GENERAL TERMS AND CONDITIONS:

This warranty shall not apply to damage due to acts of God, normal wear and tear, normal maintenance services and the parts used in connection with such service, lightning or conditions beyond the control of the manufacturer, nor shall it apply to products which, in the sole judgment of the manufacturer, have been subject to negligence, abuse, accident, misapplication, tampering, alteration; nor due to improper installation, operation, maintenance or storage; nor to excess of recommended maximums as set forth in the instructions. Warranty will be VOID if any of the following conditions are found:

1. Product is used for purposes other than those for which it was designed and manufactured
2. Product not installed in accordance with applicable codes, ordinances, and good trade practices
3. Product connected to voltage other than indicated on nameplate or labels
4. Pump exposed to but not limited to the following: sand, gravel, cement, grease, plaster, mud, tar, oil, gasoline, solvents or other abrasive or corrosive substances
5. Pump has been used for pumping liquids above 120°F
6. Pump allowed to operate dry (liquid supply cut off)

DISCLAIMER:

Any oral statements about the product made by the seller, the manufacturer, the representatives, or any other parties do not constitute warranties, shall not be relied upon by the user, and are not part of the contract for sale. Seller's and the manufacturers only obligation, and buyer's only remedy, shall be the replacement and/or repair by the manufacturer of the product as described above. NEITHER SELLER NOR THE MANUFACTURER SHALL BE LIABLE FOR ANY INJURY, LOSS OR DAMAGE, DIRECT, INCIDENTAL OR CONSEQUENTIAL (INCLUDING, BUT NOT LIMITED TO, INCIDENTAL OR CONSEQUENTIAL DAMAGES FOR LOST PROFITS, LOST SALES, INJURY TO PERSON OR PROPERTY, OR ANY OTHER INCIDENTAL OR CONSEQUENTIAL LOSS), ARISING OUT OF THE USE OR THE INABILITY TO USE THE PRODUCT, AND THE USER AGREES THAT NO OTHER REMEDY SHALL BE AVAILABLE TO IT. Before using, the user shall determine the suitability of the product for his/her intended use, and user assumes all risk and liability whatsoever in connection therewith.

THE WARRANTY AND REMEDY DESCRIBED IN THIS LIMITED WARRANTY IS AN EXCLUSIVE WARRANTY AND REMEDY AND IS IN LIEU OF ANY OTHER WARRANTY OR REMEDY, EXPRESSED OR IMPLIED, WHICH OTHER WARRANTIES AND REMEDIES ARE HEREBY EXPRESSLY EXCLUDED, INCLUDING BUT NOT LIMITED TO ANY IMPLIED WARRANTY OF MERCHANTABILITY OR FITNESS FOR A PARTICULAR PURPOSE, TO THE EXTENT EITHER APPLIES TO A PRODUCT SHALL BE LIMITED IN DURATION TO THE PERIODS OF THE EXPRESSED WARRANTIES GIVEN ABOVE.

Some states and countries do not allow the exclusion or limitations on how long an implied warranty lasts or the exclusion or limitation of incidental or consequential damages, so the above exclusion or limitations may not apply to you. This warranty gives you specific legal rights, and you may also have other rights which vary from state to state.

Troubleshooting

PROBLEM	POSSIBLE CAUSES	HOW TO CORRECT
If the pump does not start or run	Pump is not plugged in, switch or breaker is off	Plug pump in or turn on switch/breaker
	Check for blown fuses or tripped circuit breakers or tripped GFCI outlets	Replace fuse, reset breaker, reset GFCI outlet
	Motor thermal protector tripped	Allow pump to cool. Pump will automatically reset
If the pump runs but moves little or no water	Clogged intake screen	Clean or replace screen
	Clogged discharge hose/pipe	Remove clog
	Frozen discharge hose/pipe	Allow hose/pipe to thaw
	Pump is air locked	Clean out airlock hole with a paper clip or pipe cleaner
	Low line voltage	Check wire size and increase if necessary
	Worn, damaged or clogged pump parts	Inspect for wear, damage or clog and clean or replace if necessary
	Discharge head exceeds pump capacity	If pumping height is over 25', the pump will not move water. See performance chart

Safety Information (continued)

⚠ CAUTION This pump motor is equipped with an automatic resetting thermal protector and may restart unexpectedly.

⚠ WARNING Do not use this pump for potable/drinking water. Use only in applications for which the pump is designed for.

Description

This submersible sump pump is designed to remove water from, flooded basements, window wells and stock tanks. The permanent split capacitor motor is oil filled and hermetically sealed for cooler operation. The pump comes equipped with a 10' - 3-prong grounding type power cord.

Specifications

Model: MLP71025	
HP	1/5
Volts	120 volt AC
Amps	3.6
Hz	60 Hz
Phase	1
Motor Duty	Continuous*
Circuit Requirements	15 Amp minimum
Discharge Size	1-1/4" FNPT & 3/4" GHT (with included adapter)
Max. Solids Handling	1/8" (3 mm) Spherical
Liquid Temperature Range	32°F - 120°F
Cord Length	10' (3m)
Minimum basin diameter	6" (15 cm)
Pump Construction	Thermoplastic
Impeller	Thermoplastic
Motor Shaft	Stainless Steel
Shaft Seal	Carbon/Ceramic/Stainless Steel

*For continuous operation, the water depth must be at least 6" (15cm) to prevent the motor from overheating.

Installation

1. Connect a hose to the pump discharge. Use either the supplied garden hose adapter or other hose fitting (sold separately)
2. Place the pump on a solid surface in at least 1" of water. Do not place the pump directly in mud, sand, silt or on rocky surfaces as these materials can clog or cause damage the pump.

Operation

1. Connect the plug into a 120 volt AC grounded outlet. The use of a GFCI is strongly recommended.
2. The pump will not remove all water. It will drain water down to approximately 1/8"-1/4" of the floor.
3. Do not let the pump run dry. The pump depends on water for cooling and lubrication. Operating the pump without water may cause the motor to overheat or cause damage to internal parts. It may also shorten the life of your pump.
4. This pump is equipped with an anti-airlock hole. A stream of water will emit from this hole when the pump is operating. This is a normal feature of this pump. The anti-airlock hole should be cleaned periodically to prevent the pump from becoming air locked.
5. Your pump motor is thermally protected. It is not recommended for pumping liquids over 120° F (49° C). The thermal overload protector will automatically shut down the pump in an overheat situation. The pump will reset itself once the pump cools down. This overload is designed as a safety device and it will fail after repeated use. Normal operation is for fluids between 32° F & 120° F (0° C - 49° C).

Maintenance

⚠ DANGER Risk of electric shock. Always disconnect the power supply before attempting to install, service or perform maintenance on the pump.

⚠ WARNING All repairs must be made by an authorized service center.

⚠ CAUTION This submersible pump contains oil which may become pressurized and hot under normal operating conditions - allow the pump to cool for 2-3 hours before servicing.

1. The pump motor is hermetically sealed in the housing and does not require any service. Disassembly of the motor housing or modification of the power cord voids the warranty.
2. Periodically check the removable intake screen for obstructions. Clean if necessary.
3. Inspect the impeller for signs of wear and obstructions.
4. Inspect the power cord for signs of damage or wear. Do not operate the pump if the cord is damaged or worn.

Performances

Height, piping restriction and hose length will reduce the pump output performance. It is recommended to use the same size or larger pipe / hose as the pump discharge for optimum performance. The performances listed below were obtained by using 1-1/4" hose. The use of a garden hose will reduce the output depending on size and length of hose used.

Model	Discharge Height	0'	5'	10'	15'	20'	25'
MLP71025	Gallons Per Minute	26	21	14	10	7	1

Replacement Parts

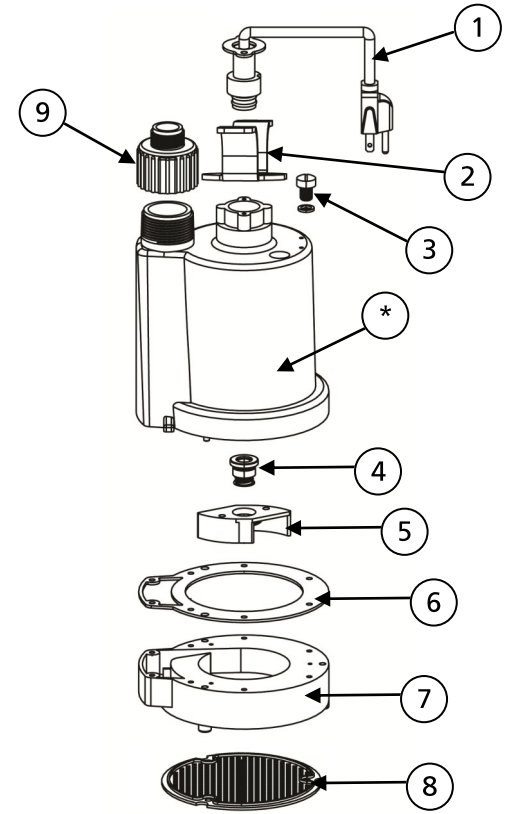

Ref#	Description	MLP71025
1	Power Cord	99008
2	Handle	99051
3	Oil Fill Plug	99056
4	Shaft Seal	99057
5	Impeller	99060
6	Gasket	99062
7	Pump Base/Volute	99067
8	Intake Screen	99073
9	Garden Hose Adapter	99006

*If motor fails, replace entire pump